

## The Ellesse Range

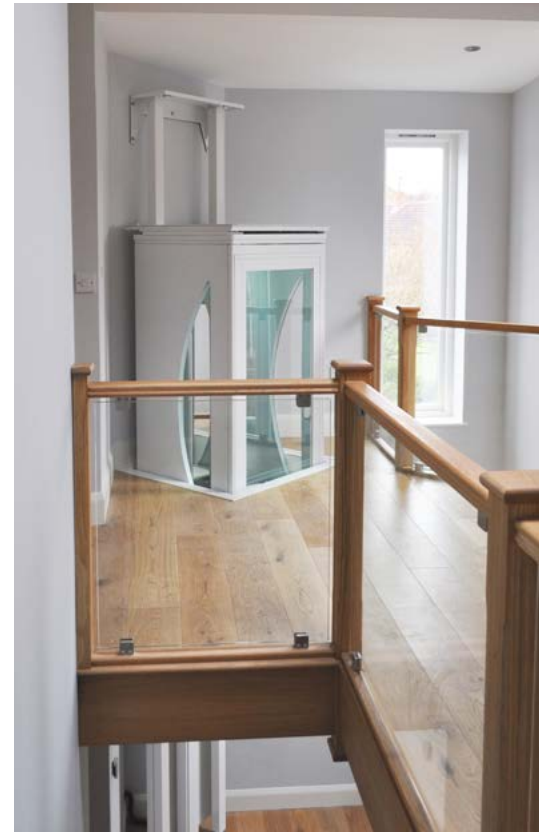



**The Wessex Ellesse** has become the new market leader in terms of elegance and luxury in the home lift market. It is a high specification iteration of our VE lift in some ways, but the design has been so greatly overhauled that it fits into an ultra-luxurious class of its own.

A wide choice of colours, finishes, and styles makes the Ellesse easier than ever to tailor a lift to suit your home. With no requirement for a wall, construction work is minimal and the lift can be fitted practically anywhere in your home.

The Ellesse means luxury and elegance in a compact, practical package.

Elegant  
Luxurious  
Stylish

Simplicity  
Excellence  
Creativity



# Options and Features

- Travel up to 3.5m
- Power door
- Automatic LED spotlights
- High quality, illuminated internal buttons
- Wireless call stations
- Choice of floor finishes (see below)
- Automatic internal lighting
- Emergency manual lowering
- Battery backup
- Roof and under-floor protection



# Technical Specification

Elesse 15/25

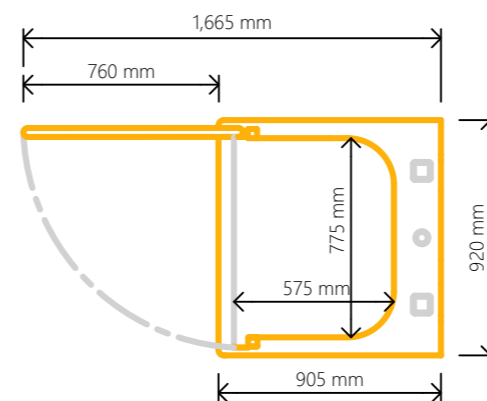

Elesse 36/56

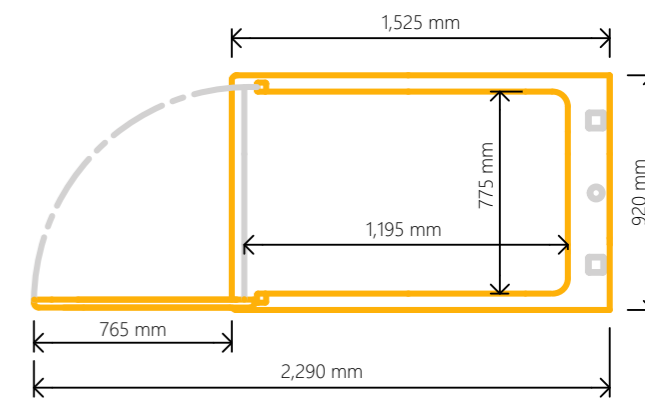

As Standard

Internal Colour



Senoual

Internal Flooring



Slate Effect

Other Options \*

Internal Colour

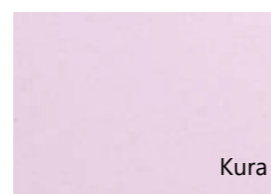

Kura

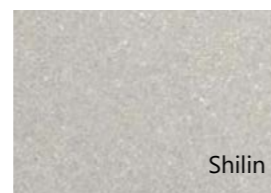

Shilin

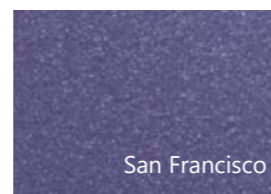

San Francisco

Internal Flooring

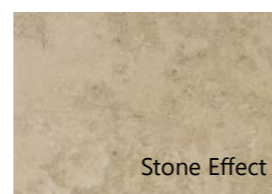

Stone Effect

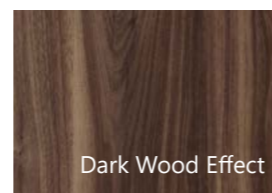

Dark Wood Effect

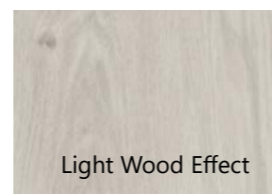

Light Wood Effect

\* Other colours are available as a cost option. Please enquire for more details

	Elesse 15	Elesse 25	Elesse 36	Elesse 56
Safe Working Load Kg	250	250	250	250
Usable Platform Dimensions mm	775 x 575	775 x 575	775 x 1195	775 x 1195
Lift Footprint Dimensions mm	920 x 905	920 x 905	920 x 1525	920 x 1525
Lift Length With Door Open mm	1665	1665	2290	2290
Minimum Upper Floor Ceiling Height mm	2180	2315	2180	2315
Mid-Floor Dimensions mm	165 - 385	165 - 385	165 - 385	165 - 385
Lift Speed mm/sec	60	60	60	60
Maximum Travel mm	3000	3500	3000	3500

✓ CE Marked



## Range

The Wessex Ellesse is the ultimate in design inspiration.

Building on an impressive pedigree spanning over four decades of design innovation, the Ellesse encapsulates the qualities embedded in every Wessex lift.

Wessex, the iconic British market leader in personal lifts.

## Customer Care

At Wessex Lifts, what matters is total Customer care and attention.

Wessex offers a complete service package – from project feasibility and professional advice, to home assessment, manufacture, installation and after sales service. From the time of your initial inquiry, our experienced personnel are on hand to offer the diamond class of personal service at every stage of your journey with us.

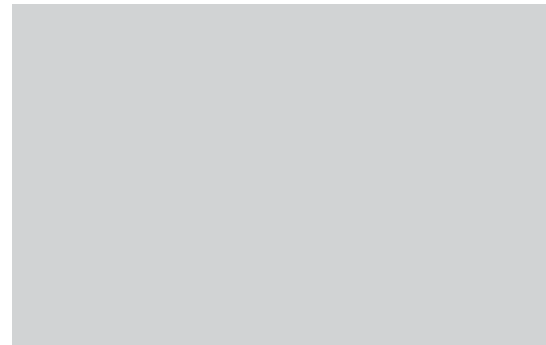

### Other lifts available from the Wessex range



Wessex Lift Co. Ltd.,  
Budds Lane, Romsey,  
Hampshire, SO51 0HA

Tel: 01794 830303  
info@wessexlifts.co.uk

[www.wessexlifts.co.uk](http://www.wessexlifts.co.uk)

British Design & Manufacture



Ref LS00 7504  
Issue E  
Language UK